

---

**aspect** 

Platform  
Specification  
Sheet.

---





Versatile in design,  
the Platform table  
can be customised to  
suit the personality of  
your space.

The Platform system boasts a casual yet refined profile that lends itself to a multitude of styles and spaces.

With its slim, angular design, Platform tables are ideal for any meeting or break-out setting.

Platform is available in both table and leaner heights, and can be powdercoated in any colour. Mix and match the top and base finishes of your Platform table to compliment your stools, chairs and decor accents.

# Aspect Design.



**As furniture designers, our user-centric approach places people at the heart of every decision we make.**

Applying 40+ years' of experience and craftsmanship, we create furniture to inspire and support people in their work every day. Manufacturing locally, and with full in-house design capability, we collaborate with interior designers, architects and clients to tailor-make environments.

We're here to support you in creating workplaces that encourage productivity, creativity and collaboration. High-performing spaces where high-performing people are empowered to do their best work.

---

# Product specifications.

---

An Aspect product. Designed by Aspect.  
Made in Australia.

---

## Variations

Table  
Leaner

## Tabletop and sub-frame finishes

### Laminate finishes



Snowdrift



Warm  
White



Rock  
Salt



Affinity  
Maple



Seal  
Grey



Storm



Raw  
Birchply



Rural  
Oak



Black



Blackened  
Legno



Refined  
Oak



Hamptons  
Elm

Linoleum and Melteca finishes, with Dulux powdercoat colours, see pages 6, 7

## Warranty

10-Year warranty for normal commercial use

## Lead time

4 - 8 Weeks

---

# Product specifications.

## Platform table.

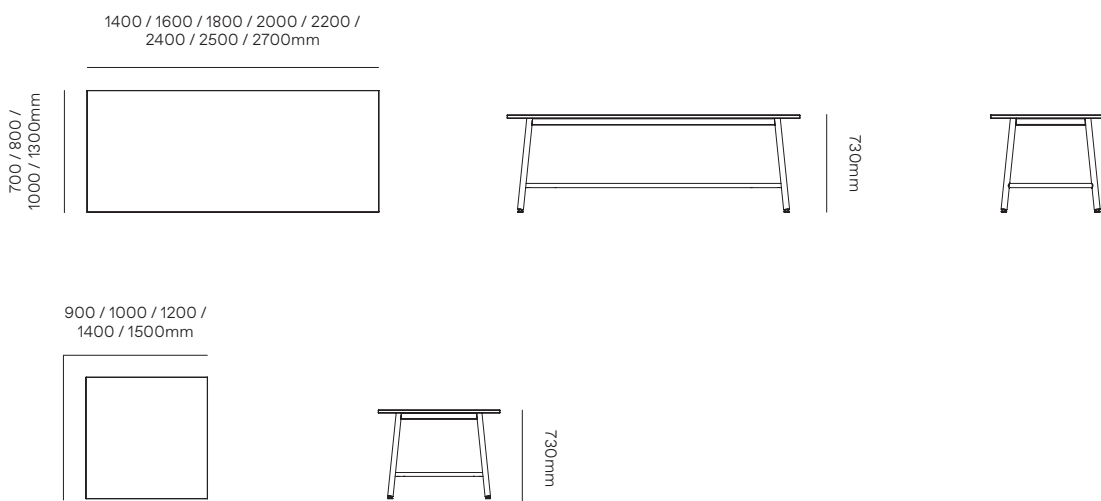



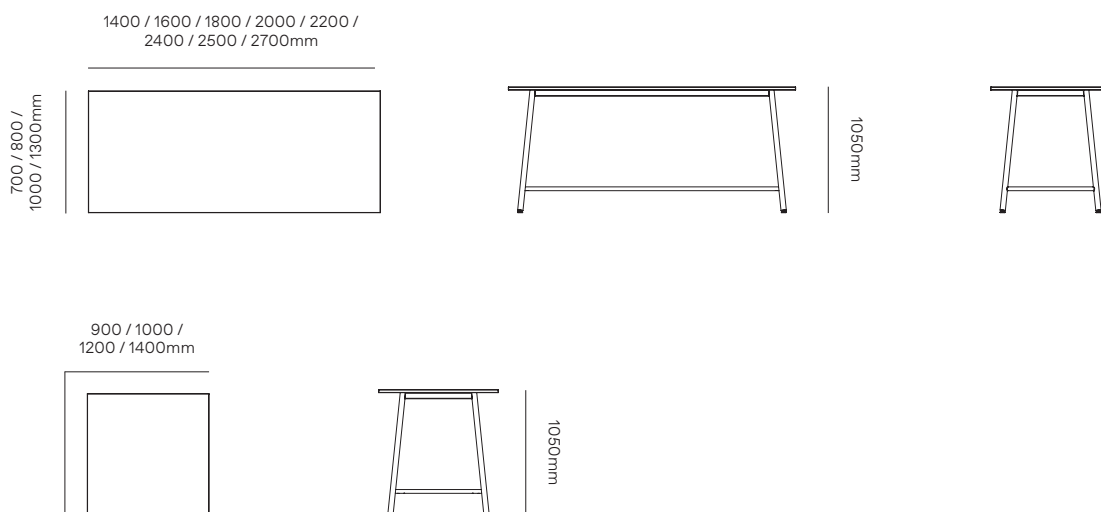

## Platform leaner.







# Product specifications.



Forbo Furniture linoleum and Dulux powdercoat colour matches.



<b>FORBO FURNITURE</b>	<b>DULUX POWDERCOAT</b>
	
<b>Aquavert</b> #86babd RGB: 134, 186, 187	<b>Jay Matt</b> Duralloy Solid



<b>FORBO FURNITURE</b>	<b>DULUX POWDERCOAT</b>
	
<b>Burgundy</b> #4a2123 RGB: 74, 33, 35	<b>Scoria Matt</b> Duralloy Solid



<b>FORBO FURNITURE</b>	<b>DULUX POWDERCOAT</b>
	
<b>Conifer</b> #083025 RGB: 134, 186, 187	<b>Permanent Green</b> Duralloy Solid

<b>FORBO FURNITURE</b>	<b>DULUX POWDERCOAT</b>
	
<b>Midnight Blue</b> #2b598a RGB: 41, 89, 139	<b>Pommel Blue Gloss</b> PG28



<b>FORBO FURNITURE</b>	<b>DULUX POWDERCOAT</b>
	
<b>Nero</b> #000000 RGB: 0, 0, 0	<b>Mannex Black</b>

<b>FORBO FURNITURE</b>	<b>DULUX POWDERCOAT</b>
	
<b>Olive</b> #808570 RGB: 128, 133, 113	<b>Misty Green Matt</b> Duralloy Solid

<b>FORBO FURNITURE</b>	<b>DULUX POWDERCOAT</b>
	
<b>Orange Blast</b> #4a2123 RGB: 234, 94, 41	<b>Orange X15 Gloss</b> PG288

<b>FORBO FURNITURE</b>	<b>DULUX POWDERCOAT</b>
	
<b>Pistachio</b> #c1cbb4 RGB: 193, 203, 180	<b>Bone White Gloss</b> Duralloy Solid

<b>FORBO FURNITURE</b>	<b>DULUX POWDERCOAT</b>
	
<b>Pistachio</b> #c1cbb4 RGB: 193, 203, 180	<b>Bone White Gloss</b> Duralloy Solid

<b>FORBO FURNITURE</b>	<b>DULUX POWDERCOAT</b>
	
<b>Salsa</b> #9b2721 RGB: 155, 42, 34	<b>Bright Red Gloss</b> PG288

# Product specifications.

Melteca and Dulux powdercoat colour matches.

MELTECA	DULUX POWDERCOAT
<b>Bayleaf</b> #9fa790 RGB: 159, 167, 144	<b>Mist Green Matt</b> Duralloy Solid

MELTECA	DULUX POWDERCOAT
<b>Char Blue</b> #3f3d40 RGB: 63, 61, 64	<b>Solid Gravel Matt</b> Duralloy Solid

MELTECA	DULUX POWDERCOAT
<b>Energise</b> #ee782c RGB: 238, 120, 44	<b>Orange X15 Gloss</b> PG288

MELTECA	DULUX POWDERCOAT
<b>Green Slate</b> #6b7769 RGB: 107, 119, 105	<b>Bond Rivergum Matt</b> Duralloy Solid

MELTECA	DULUX POWDERCOAT
<b>Juicy</b> #8ab5ef RGB: 138, 181, 63	<b>Leaf Satin</b> Duratec Intensity

MELTECA	DULUX POWDERCOAT
<b>Memphis Blue</b> #2c508a RGB: 44, 80, 138	<b>Royal Blue Glass</b> PG288

MELTECA	DULUX POWDERCOAT
<b>Memphis Red</b> #cb322c RGB: 203, 50, 44	<b>Cola Red Satin</b> Duralloy Solid

MELTECA	DULUX POWDERCOAT
<b>Olympia Yellow</b> #fab25 RGB: 250, 186, 37	<b>Sunshine Gloss</b> Duratec Intensity

MELTECA	DULUX POWDERCOAT
<b>Province Blue</b> #51708d RGB: 80, 112, 141	<b>Wedgewood Matt</b> Duralloy Solid

MELTECA	DULUX POWDERCOAT
<b>Spinifex</b> #b1bcb2 RGB: 177, 188, 178	<b>Bone White Gloss</b> Duralloy Solid

MELTECA	DULUX POWDERCOAT
<b>Snowdrift Naturale</b> #fafafa RGB: 250, 250, 250	<b>Mannex White</b>

MELTECA	DULUX POWDERCOAT
<b>Standard Black</b> #cb322c RGB: 203, 50, 44	<b>Mannex Black</b> Duralloy Solid

MELTECA	DULUX POWDERCOAT
<b>Winter Sky</b> #5b6e75 RGB: 91, 110, 117	<b>Wizard Matt</b> Duralloy Solid



We are creative problem solvers that champion original thinking. We love sharing ideas, taking something and making it better together.

Please get in touch with us, we'd love to discuss your project.

**Australia**

1800 696 334

[infoau@aspectfurniture.com](mailto:infoau@aspectfurniture.com)

**New Zealand**

0800 323 220

[info@aspectfurniture.com](mailto:info@aspectfurniture.com)

[aspectfurniture.com](http://aspectfurniture.com)