

---

aspect 

Forum  
Specification  
Sheet.

---

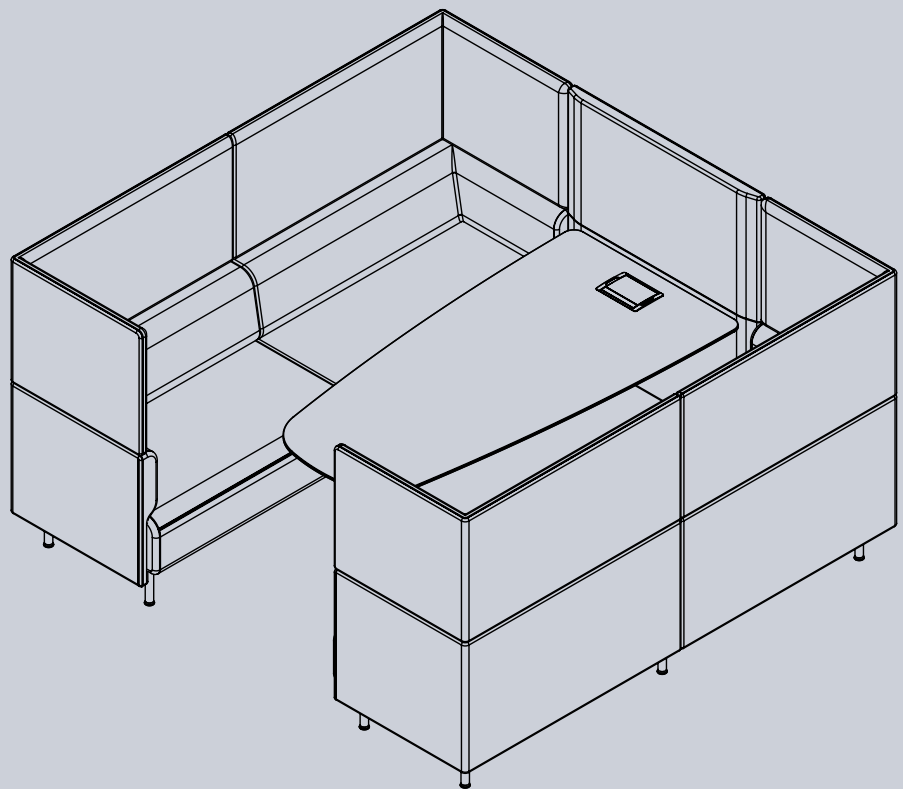



Built for both individual focus and collaborative conversation.

Forum sofas placed facing one another form small, intimate meeting areas. When isolated, they provide a quiet space to think – a place of refuge in a busy office.

Crafted around the user experience, Forum provides ultimate support and seamlessly integrates into workplace environments. Carefully selected materials ensure low environmental impact, strength and durability.

# The Forum range starts with a single, two or three seater.



Featuring a variety of low or high back sofas and booths with connecting media panel. Integrated tables and visual displays can be added for further functionality.

By combining comfort, flexibility and adjustability, Forum ensures that your workplace remains agile and resilient to evolving work styles and user needs.

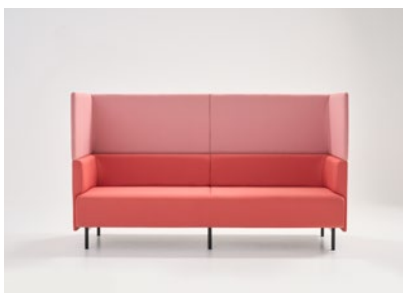

# The Forum booth is a place to meet, present and collaborate.



Featuring power and integrated work surfaces, Forum booths can be easily accessorised with displays to provide additional functionality.

The Forum booth is available in 2, 4 and 6-seater configurations to suit your space and needs.



# Aspect Design.



**As furniture designers,  
our user-centric approach  
places people at the heart  
of every decision we make.**

Applying 40+ years' of experience and craftsmanship, we create furniture to inspire and support people in their work every day. Manufacturing locally, and with full in-house design capability, we collaborate with interior designers, architects and clients to tailor-make environments.

We're here to support you in creating workplaces that encourage productivity, creativity and collaboration. High-performing spaces where high-performing people are empowered to do their best work.

---

# Product specifications.

---

An Aspect product. Designed by Aspect.  
Made in Australia.

---

<b>Finishes</b>	Choose from fabric, leather or vinyl Upholstered in Australia
<b>Variations</b>	Sofa modules, booth modules Standard Ash Timber or powdercoated Mannex Black steel legs
<b>Warranty</b>	10-Year warranty for normal commercial use Fabric as per manufacturers warranty
<b>Lead Time</b>	4–8 weeks

# Forum collection.

## Forum sofa.

Single seater.

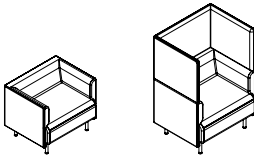

Low back. High back.

Two seater.

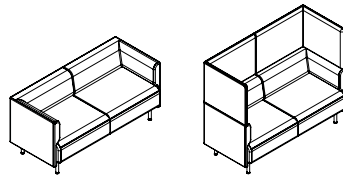

Low back. High back.

Three seater.

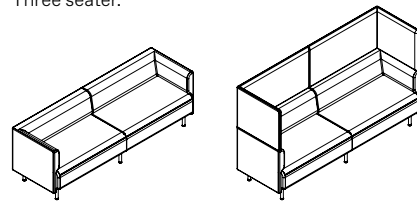

Low back. High back.

## Forum booth.

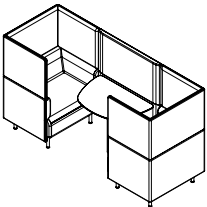

Two seater.

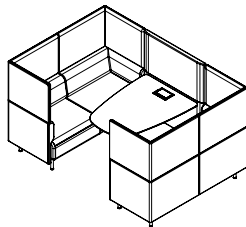

Four seater.

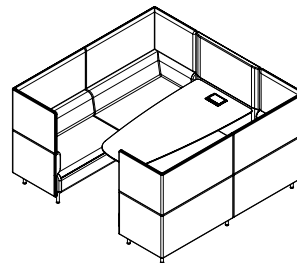

Six seater.

## Forum module seat height & foot detail.

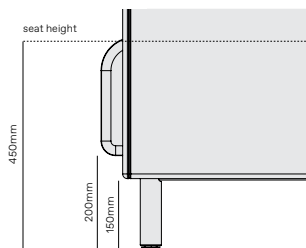

Timber legs.

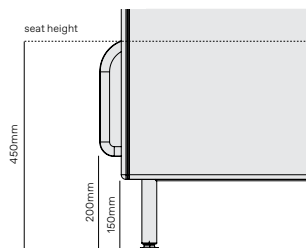

Steel legs.

# Sofa specifications.

## Single seater.

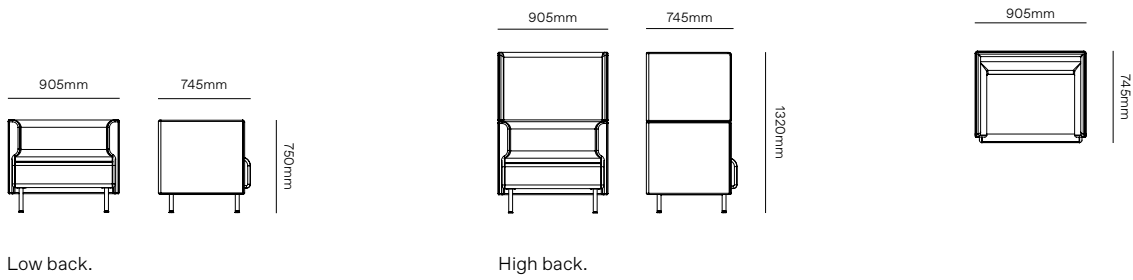

Low back.

High back.

## Two seater.

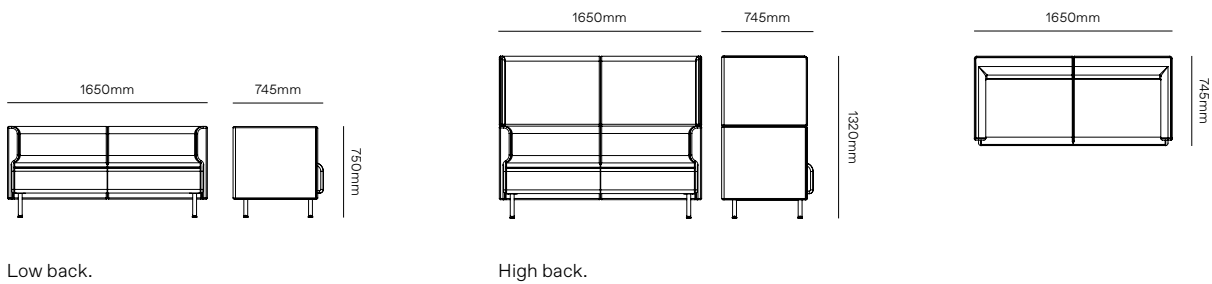

Low back.

High back.

## Three seater.

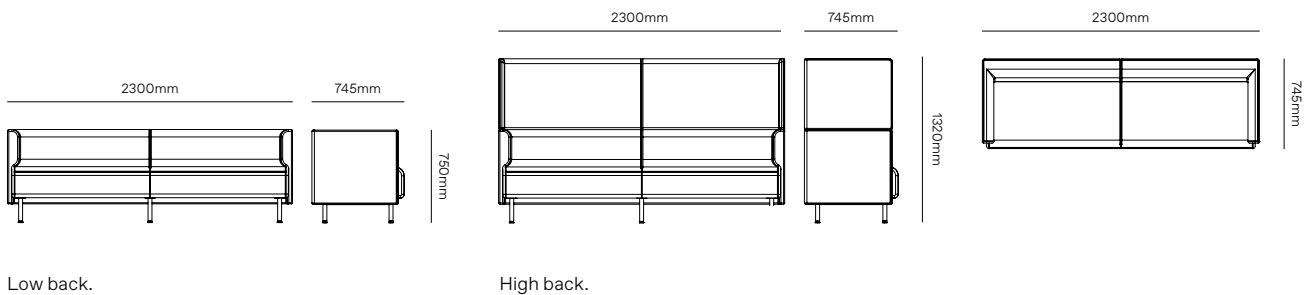

Low back.

High back.

Available with either solid timber or steel legs.

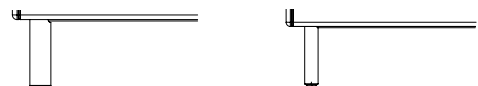



# Booth specifications.

## Two seater.

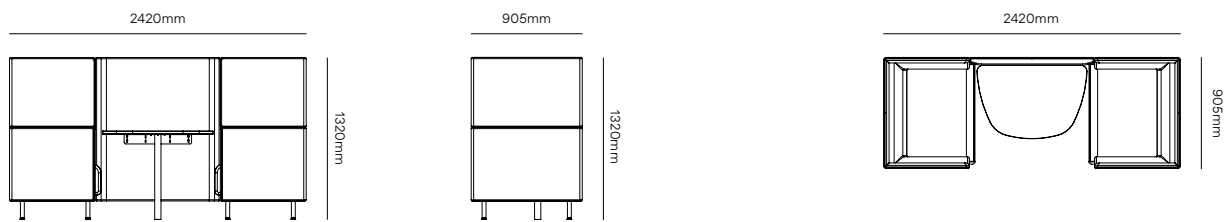

## Four seater.

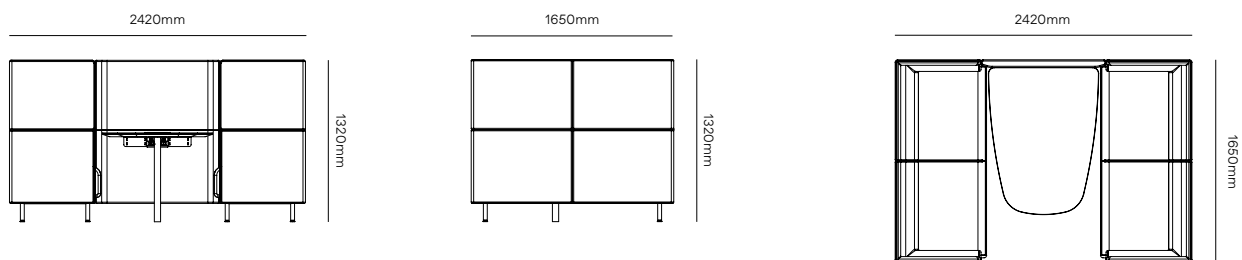

## Six seater.

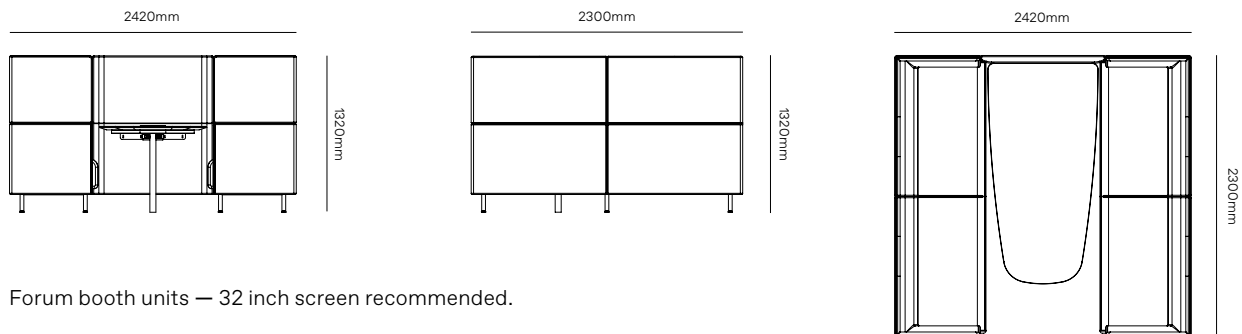

Forum booth units — 32 inch screen recommended.

Available with either solid timber or steel legs.





We are creative problem solvers that champion original thinking. We love sharing ideas, taking something and making it better together.

Please get in touch with us, we'd love to discuss your project.

**Australia**

1800 696 334

[infoau@aspectfurniture.com](mailto:infoau@aspectfurniture.com)

**New Zealand**

0800 323 220

[info@aspectfurniture.com](mailto:info@aspectfurniture.com)

[aspectfurniture.com](http://aspectfurniture.com)