

# Smartalock.



aspect 

$\frac{5C}{52}$

$\frac{5C}{55}$

$\frac{5C}{58}$

$\frac{5C}{61}$

$\frac{5C}{64}$

$\frac{5C}{67}$

$\frac{5C}{53}$

$\frac{5C}{56}$

$\frac{5C}{59}$

$\frac{5C}{62}$



$\frac{5C}{65}$

$\frac{5C}{68}$

$\frac{5C}{54}$

$\frac{5C}{57}$

$\frac{5C}{60}$

$\frac{5C}{63}$

$\frac{5C}{66}$

$\frac{5C}{69}$



# Smartalock intelligent storage.



Innovative lock hardware combined with powerful applications in a complete package.

Storage solutions for the workplace are changing rapidly as organisations are embracing agile and activity-based working principles. Flexible workspaces are leading to the sharing of desks and less individual storage at the desk itself.

Smartalock can be used in existing storage lockers and does not require a visible lock or handle. It's the perfect solution for seamless locker designs that blend into walls, floor consoles or custom furniture.

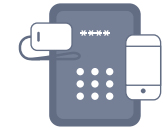

#### Card + smartphone + kiosk = all bases covered

Users get access to lockers with existing building access cards, as well as our free Smartphone application or via the included touchscreen kiosk.



#### Smart design with solid hardware

Designed in Australasia by experienced furniture manufacturers in conjunction with experts in electrical engineering and software development.



#### Powerful user applications all-included

The Smartalock app extends the functionality of a traditional locker by integrating features not possible even with other so-called smart locker systems.



#### Ultra low maintenance

Unlike battery powered locks, Smartalock is mains powered (with optional UPS backup). No yearly replacement of batteries.



An optional built-in USB charging port can be included in each locker so users can leave their devices to charge inside.

### Always-on visibility

A front-side indicator light informs users about locker availability at a glance.

Bright internal LED lighting switches on when the lock releases, making it easy to see inside even in low-light environments.

### Innovative lock hardware

Locks can be mounted on both the left or right side to suit all door configurations and locker types.

Locker doors are opened and closed through pushing on a soft plunger mechanism that allows for handle-less locker doors and seamless design.

Lockers also feature a power-out mechanical release for emergency access with a special tool or mechanical switch box.

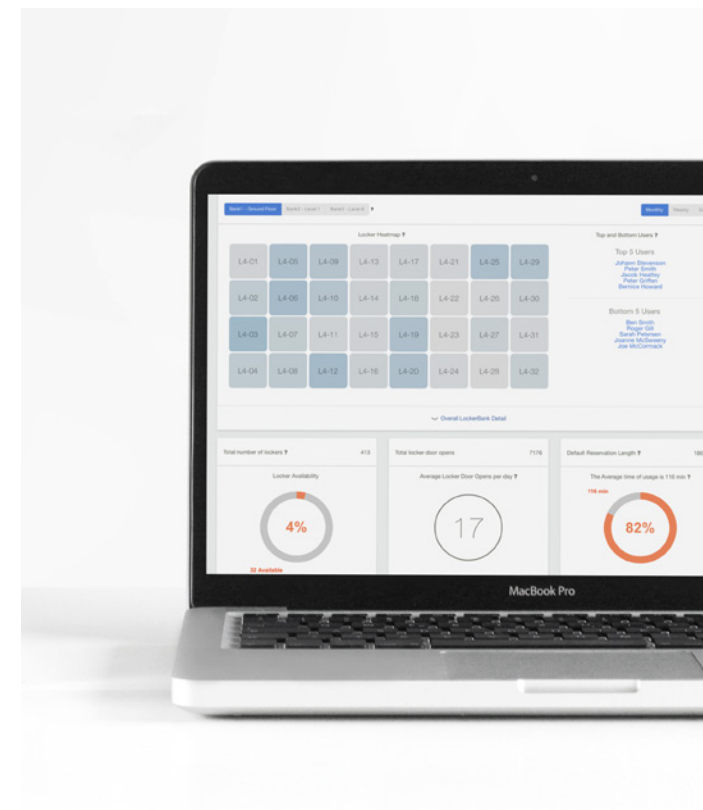

### Admin and analytics

Administrators have complete control over fixed or dynamic locker assignment.

The Smartalock administration system offers more than other smart-locker systems, with its user-friendly interface and deep insight into locker analytics.

Included free with every system, Smartalock analytics provide a detailed breakdown of locker usage, top and low users, and real-time locker availability.



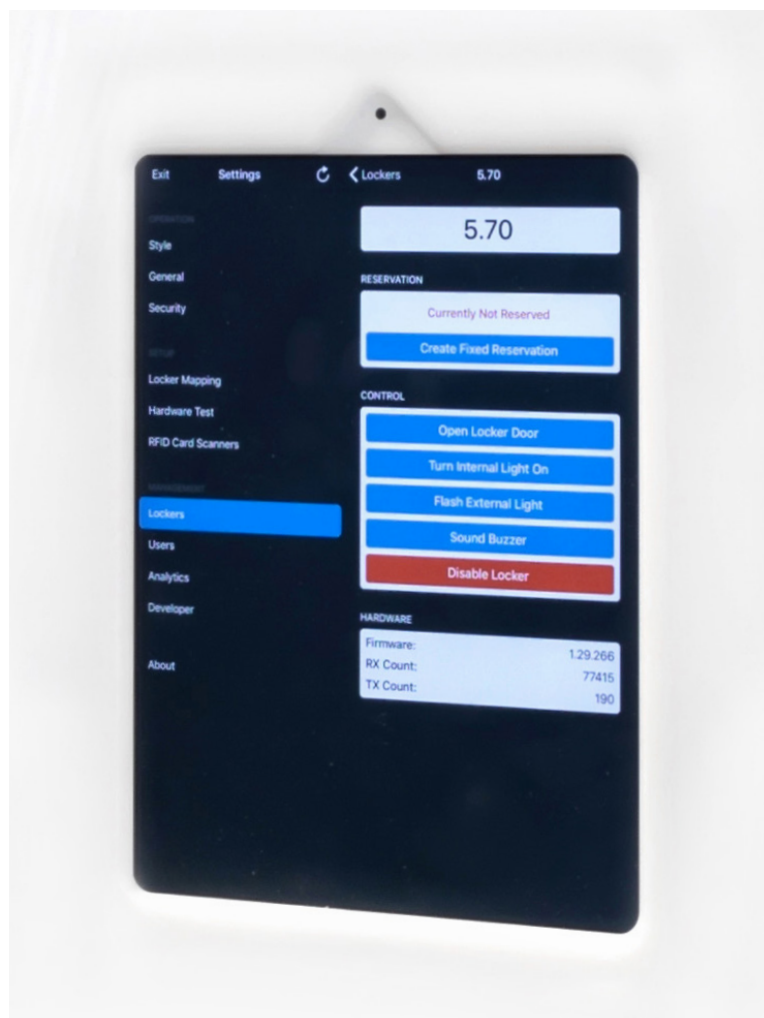

The touchscreen kiosk allows locker access and control without the use of a smartphone or access card, while the built-in card reader reads practically every available card type – 13.56mHz and 125kHz.

## Integrated connectivity

A simplified cabling system carries both power and data in single standard Cat5E cables.

For remote admin an optional office WiFi connection can be integrated, but is not necessary for operation.

A LAN port is also included for optional connection to the office ethernet network.

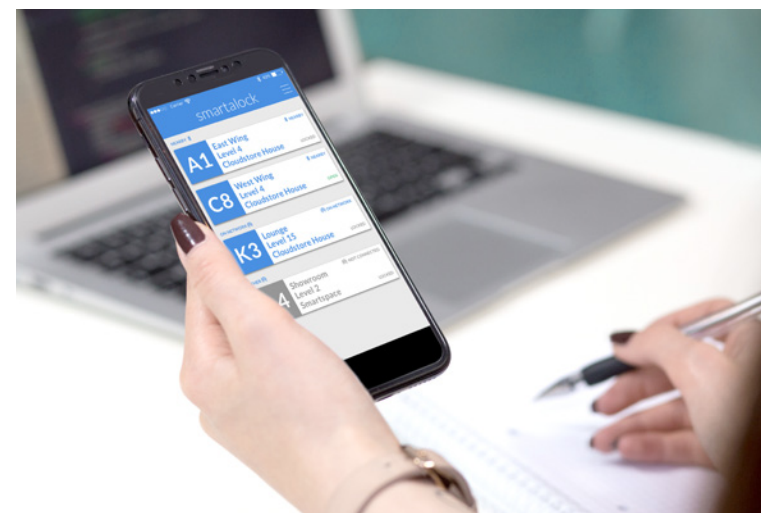
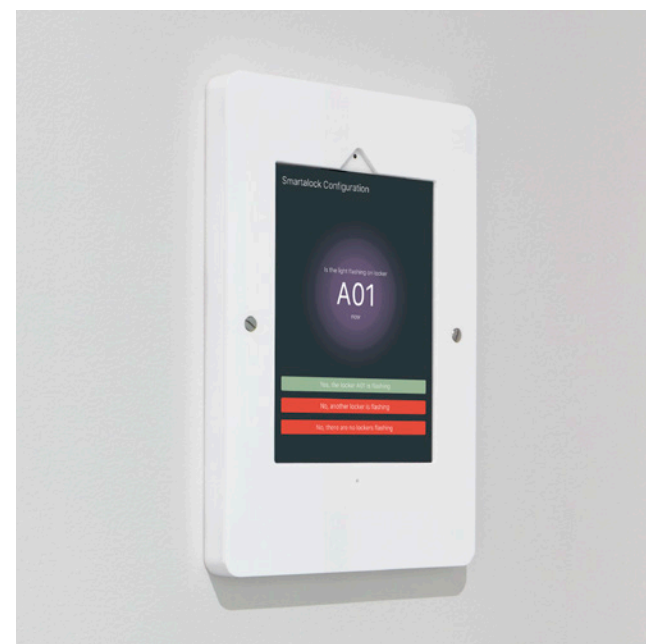
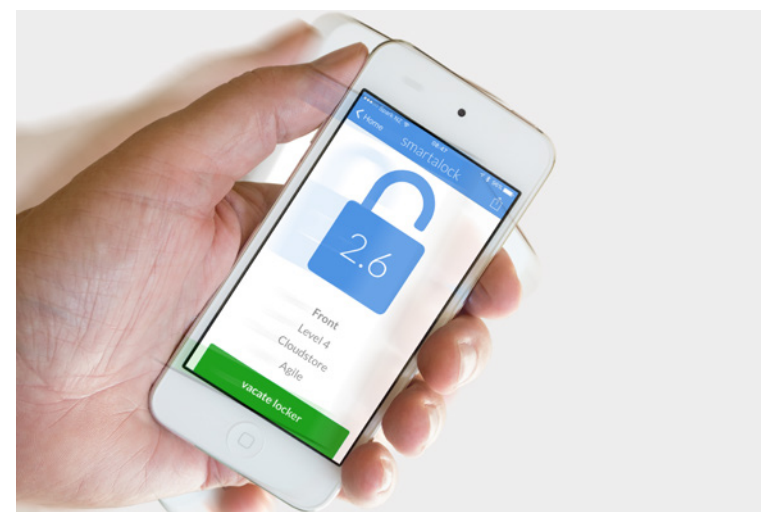

## Beautifully simple software

### **Shake to unlock**

Users can open their lockers by approaching the locker area and simply shaking their smartphone.

### **Intelligent locker sharing**

Share access to single lockers amongst multiple Smartlock App users via SMS or email.

### **Simple setup**

Smartlock offers wizard-based first-time configuration and an intuitive on-going operational interface.

### **Built-in analytics**

In-depth reports assist with improving locker placement, locker-to-user ratios and saving floor space.

# Standard Smartalock locker configurations

Custom sizes and variations are available on request.

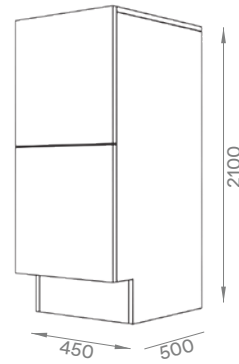

**2-Tier low**  
150mm toekick

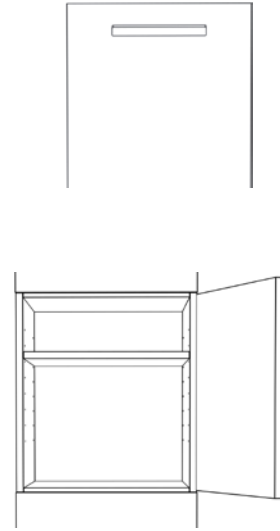

**Mail slot**  
25mm x 230mm

**Adjustable shelf**

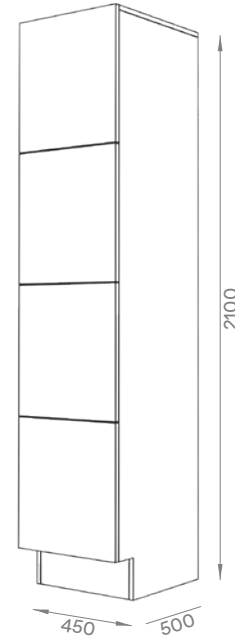

**4-Tier**  
150mm toekick

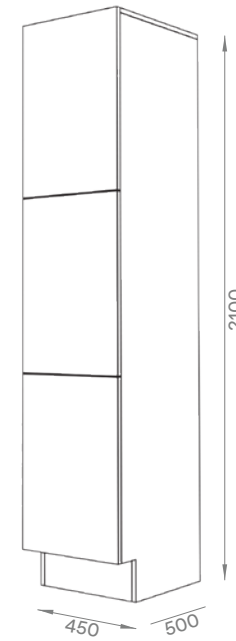

**3-Tier**  
150mm toekick

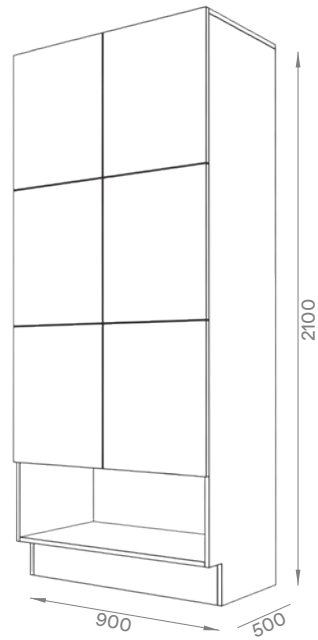

**3-Tier double open bay**  
150mm toekick  
300mm open bay

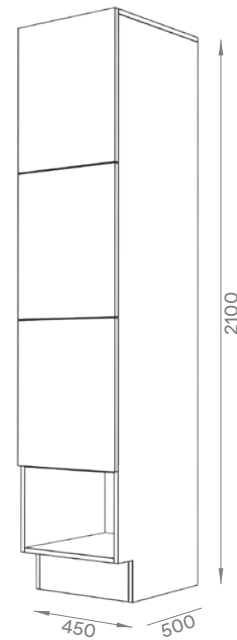

**3-Tier open bay**  
150mm toekick  
300mm open bay

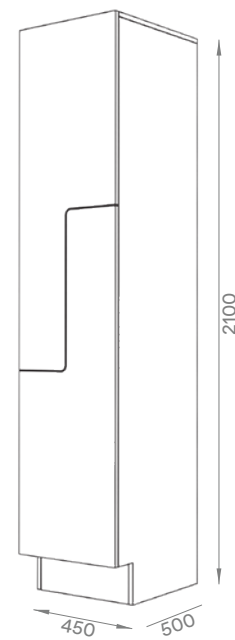

**2-Step**  
150mm toekick

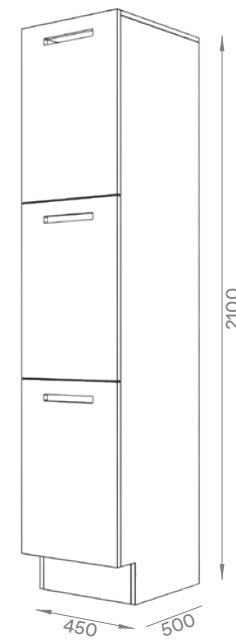

**3-Tier with mail slot**  
150mm toekick





## Standard finishes

Custom finishes are available on request.

### Laminex

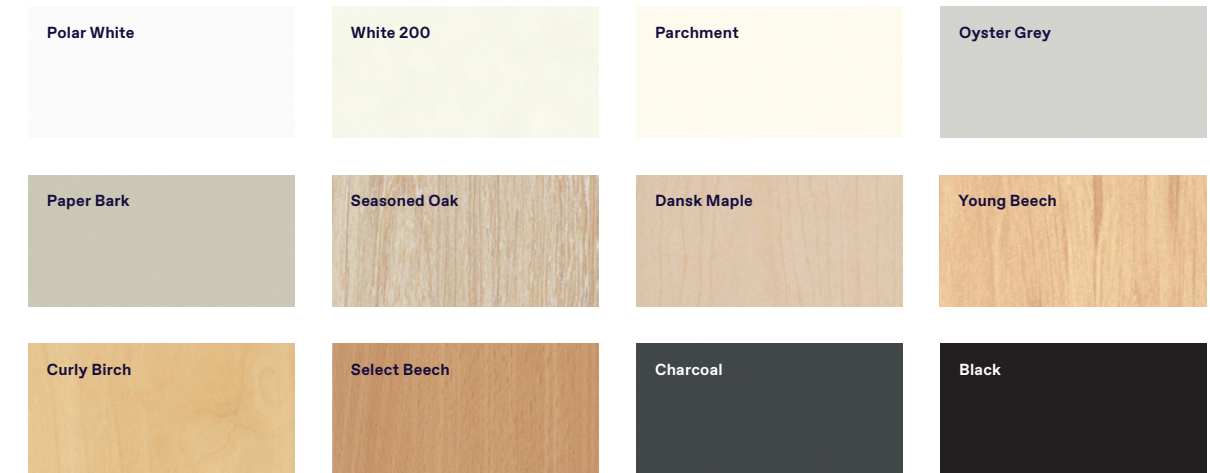

### Polytec Commercial

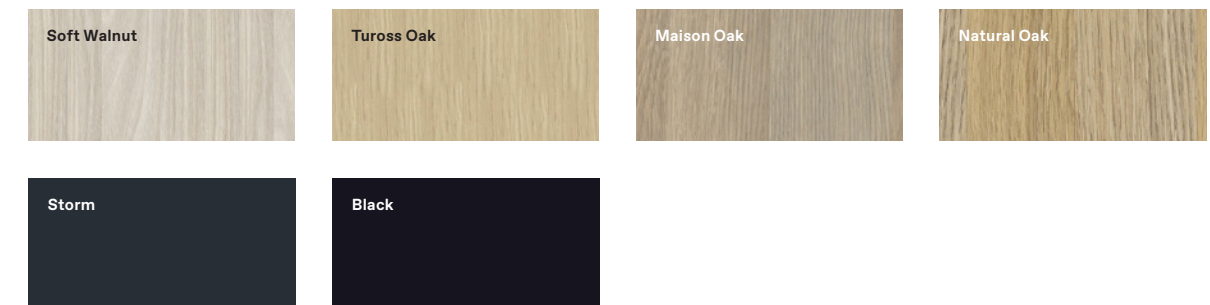

### Polytec Ravine

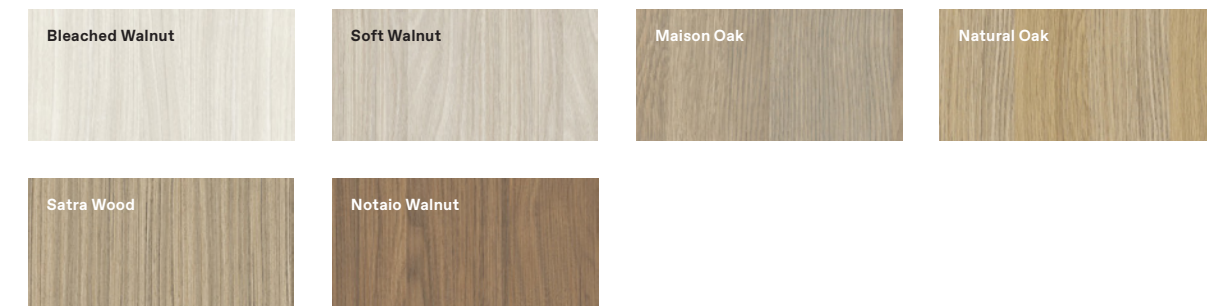

# WorkTote personal storage.



The WorkTote is a handy storage accessory designed for agile or activity-based working spaces and can be retrofitted to lockers, maximising the storage space inside.

The slimline, foldable aluminium handle locks in place to assist in carrying heavy items such as laptops.



**Designed by Aspect, the WorkTote allows staff to easily move from their locker to a workpoint and around the office with their essentials.**

A swivelling bracket allows the WorkTote to function as an under-desk drawer and easily slides into a custom-made rail which can be mounted under worktops. The specially designed clamp works with any worktop including a 'sharknose' or 'tapered' style and can be located anywhere along the desk edge.

One half of the WorkTote has removable dividers for personal items and stationery, the other has space for files and tablets. Additional removable accessories include the paper taco and pen bucket and can be used separately in lockers or on desktops.

The unit is constructed from injected moulded recyclable plastic and is stocked in a range of five colours.



# WorkTote

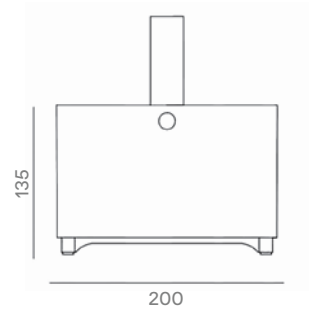
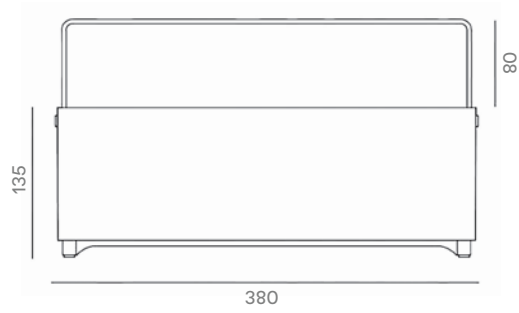

## Standard colours

Customised colours are available for production runs of 1000 units and above. The slimline, foldable handle is constructed from black powdercoated aluminium.

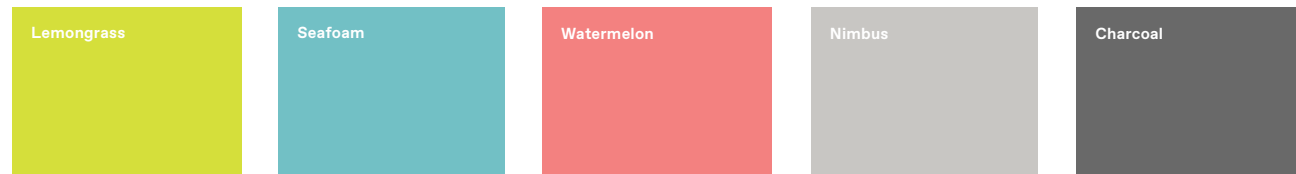

Pen holder and paper taco



WorkTote rail



WorkTote swivel

L2.139

L2.140



**Showrooms**

Sydney  
Melbourne  
Canberra  
Auckland  
Wellington  
Christchurch

**Australia**

1800 696 334  
infoau@aspectfurniture.com

**New Zealand**

0800 323 220  
info@aspectfurniture.com

**aspectfurniture.com**